

TRU-FLOW INDUSTRIAL CO., LTD.



Pressfittings für Trinkwasser-Installation; Systemprüfzeichen DVGW: DW-8511BN0661

Pressfittings installation in portable water supply systems; Bearing DVGW: DW-8511BN0661

Material : Stainless steel Cr-Ni-Mo-steel, material NO.1.4401(316)

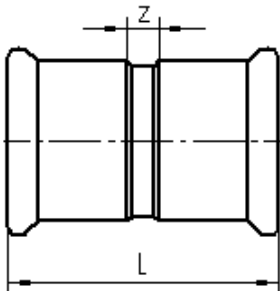
Coupling	Article	Nom dia	Outside diameter of pipe OD	L	Z	Pack	qty
Muffe	Artikel	DN	Rohr Außendurchmesser r d	L	Z	Stück pro Verpackung	
	DM-P15	12	15	48	8	20/300	
	DM-P18	15	18	48	8	20/240	
	DM-P22	20	22	50	8	20/160	
	DM-P28	25	28	54	8	20/120	
	DM-P35	32	35	62	10	10	
	DM-P42	40	42	71	11	4	
	DM-P54	50	54	83	13	4	

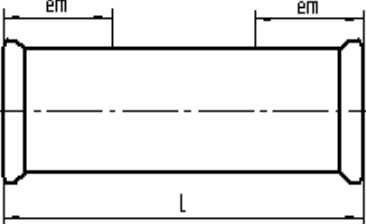
Slip coupling	Article	Nom dia	Outside diameter of pipe OD	L	Z	Pack	qty
SchiebeMuffe	Artikel	DN	Rohr Außendurchmesser r d	L	em	Stück pro Verpackung	
	DML-P15	12	15	80	25	20	
	DML-P18	15	18	80	25	20	
	DML-P22	20	22	84	25	20	
	DML-P28	25	28	91	30	20	
	DML-P35	32	35	102	30	10	
	DML-P42	40	42	120	40	4	
	DML-P54	50	54	140	40	4	

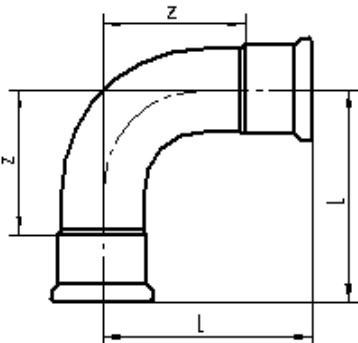
90° elbow	Article	Nom dia	Outside diameter of pipe OD	L	Z	Pack	qty
Bogen 90°	Artikel	DN	Rohr Außendurchmesser r d	L	Z	Stück pro Verpackung	
	DE9-P15	12	15	49	29	20/200	
	DE9-P18	15	18	53	33	20/140	
	DE9-P22	20	22	61	40	20/100	
	DE9-P28	25	28	72	49	10/60	
	DE9-P35	32	35	122	96	10	
	DE9-P42	40	42	166	136	2	
	DE9-P54	50	54	200	165	2	

TRU-FLOW INDUSTRIAL CO., LTD.



Pressfittings für Trinkwasser-Installation; Systemprüfzeichen DVGW: DW-8511BN0661

Pressfittings installation in portable water supply systems; Bearing DVGW: DW-8511BN0661

Material : Stainless steel Cr-Ni-Mo-steel, material NO.1.4401(316)

90° elbow with one plaine end	Article	Nom dia	Outside diameter of pipe OD	L	h	h _{min.}	Z	Pack	qty
-------------------------------	---------	---------	-----------------------------	---	---	-------------------	---	------	-----

Bogen 90° mit einseitigem Einschiebende	Artikel	DN	RohrauBendurchmesse r d	L	h	h _{min.}	Z	Stück pro Verpackung
---	---------	----	-------------------------	---	---	-------------------	---	----------------------

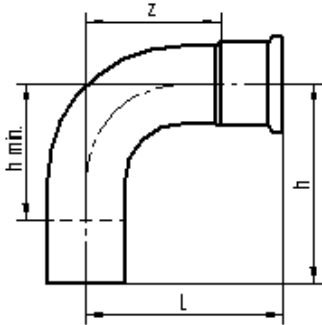

DE9S-P15	12	15	49	55	55	29	20
DE9S-P18	15	18	53	59	59	33	20
DE9S-P22	20	22	61	67	67	40	20
DE9S-P28	25	28	72	78	78	49	10
DE9S-P35	32	35	122	130	120	96	10
DE9S-P42	40	42	166	176	140	136	2
DE9S-P54	50	54	200	211	165	165	2

45° elbow	Article	Nom dia	Outside diameter of pipe OD	L	Z	Pack	qty
-----------	---------	---------	-----------------------------	---	---	------	-----

Bogen 45°	Artikel	DN	RohrauBendurchmesse r d	L	Z	Stück pro Verpackung
-----------	---------	----	-------------------------	---	---	----------------------

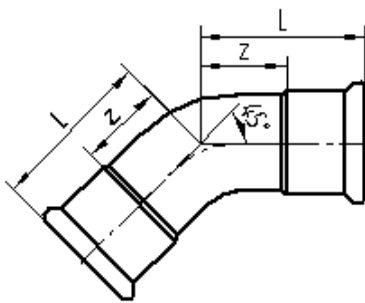

DE4-P15	12	15	36	16	20/200
DE4-P18	15	18	37	17	20/160
DE4-P22	20	22	42	21	20/100
DE4-P28	25	28	48	25	10/70
DE4-P35	32	35	72	46	10
DE4-P42	40	42	89	59	4
DE4-P54	50	54	115	80	2

45° elbow with one plaine end	Article	Nom dia	Outside diameter of pipe OD	L	h	Z	Pack	qty
-------------------------------	---------	---------	-----------------------------	---	---	---	------	-----

Bogen 45° mit einseitigem Einschiebende	Artikel	DN	RohrauBendurchmesse r d	L	h	Z	Stück pro Verpackung
---	---------	----	-------------------------	---	---	---	----------------------

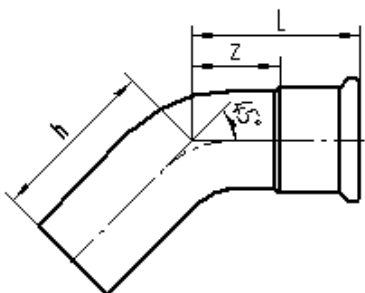

DE4S-P15	12	15	36	41	16	20/260
DE4S-P18	15	18	37	42	17	20/200
DE4S-P22	20	22	42	48	21	20/120
DE4S-P28	25	28	48	54	25	10/70
DE4S-P35	32	35	72	81	46	10
DE4S-P42	40	42	89	99	59	4
DE4S-P54	50	54	115	127	80	2

TRU-FLOW INDUSTRIAL CO., LTD.



Pressfittings für Trinkwasser-Installation; Systemprüfzeichen DVGW:DW-8511BN0661

Pressfittings installation in portable water supply systems; Bearing DVGW:DW-8511BN0661

Material : Stainless steel Cr-Ni-Mo-steel, material NO.1.4401(316)

Pre-formed pipebridge	Article	Nom dia	Outside diameter of pipe OD	L1	L2	L3	Pack	qty
Sprungbogen	Artikel	DN	Rohr Außendurchmesser r d	L1	L2	L3	Stück pro Verpackung	
	DB-P15	12	15	57	158	37	10	
	DB-P18	15	18	60	165	40	10	
	DB-P22	20	22	65	178	44	10	
	DB-P28	25	28	74	210	50	10	

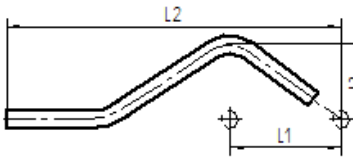

90° elbow plain ends	Article	Nom dia	Outside diameter of pipe OD	h1	h1 _{min.} *	h2	h2 _{min.} *	Pack	qty
Passbogen 90°	Artikel	DN	Rohr Außendurchmesser r d	h1	h1 _{min.} *	h2	h2 _{min.} *	Stück pro Verpackung	
	DB9-P15	12	15	70	58	120	58	20	
	DB9-P18	15	18	70	63	120	63	20	
	DB9-P22	20	22	70	70	120	70	10	
	DB9-P28	25	28	80	80	120	80	10	
	DB9-P35	32	35	120	100	200	100	4	
	DB9-P42	40	42	150	120	250	120	2	
	DB9-P54	50	54	200	145	300	145	2	

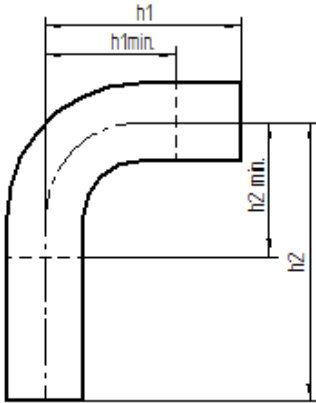

60° elbow plain ends	Article	Nom dia	Outside diameter of pipe OD	h1	h1 _{min.} *	h2	h2 _{min.} *	Pack	qty
Passbogen 60°	Artikel	DN	Rohr Außendurchmesser r d	h1	h1 _{min.} * <td>h2</td> <td>h2_{min.}* <td>Stück pro Verpackung</td> <td></td> </td>	h2	h2 _{min.} * <td>Stück pro Verpackung</td> <td></td>	Stück pro Verpackung	
	DB6-P28	25	28	63	63	121	66	10	
	DB6-P35	32	35	97	77	203	77	10	
	DB6-P42	40	42	120	90	256	90	4	
	DB6-P54	50	54	162	107	306	107	2	

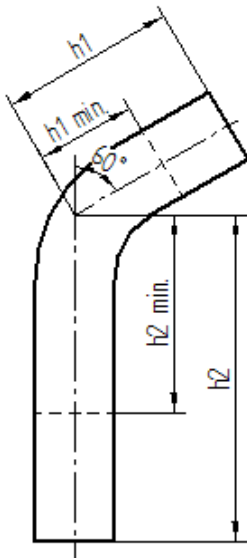

TRU-FLOW INDUSTRIAL CO., LTD.



Pressfittings für Trinkwasser-Installation; Systemprüfzeichen DVGW:DW-8511BN0661

Pressfittings installation in portable water supply systems; Bearing DVGW:DW-8511BN0661

Material : Stainless steel Cr-Ni-Mo-steel, material NO.1.4401(316)

30° elbow plain ends	Article	Nom dia	Outside diameter of pipe OD	h1	h1 _{min.}	h2	h2 _{min.}	Pack	qty
Passbogen 30°	Artikel	DN	Rohr-Bendurchmesser r d	h1	h1 _{min.}	h2	h2 _{min.}	Stück pro Verpackung	
	DB3-P28	25	28	51	51	130	54	10	
	DB3-P35	32	35	80	60	214	60	10	
	DB3-P42	40	42	99	69	272	69	4	
	DB3-P54	50	54	134	79	326	79	2	

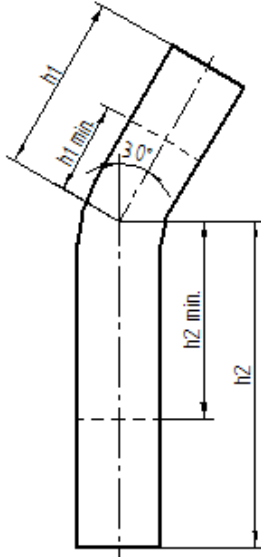

15° elbow plain ends	Article	Nom dia	Outside diameter of pipe OD	h1	h1 _{min.}	h2	h2 _{min.}	Pack	qty
Passbogen 15°	Artikel	DN	Rohr-Bendurchmesser r d	h1	h1 _{min.}	h2	h2 _{min.}	Stück pro Verpackung	
	DB1-P28	25	28	45	45	134	48	10	
	DB1-P35	32	35	73	53	222	53	10	
	DB1-P42	40	42	89	59	280	59	4	
	DB1-P54	50	54	122	67	337	67	2	

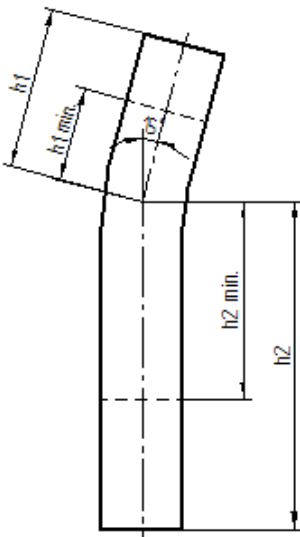

TRU-FLOW INDUSTRIAL CO., LTD.



Pressfittings für Trinkwasser-Installation; Systemprüfzeichen DVGW: DW-8511BN0661

Pressfittings installation in portable water supply systems; Bearing DVGW: DW-8511BN0661

Material : Stainless steel Cr-Ni-Mo-steel, material NO.1.4401(316)

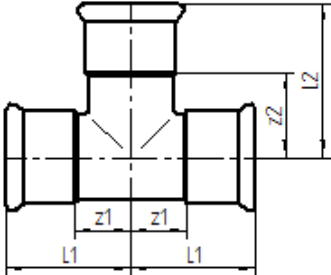
Equal tee	Article	Nom dia	Outside diameter of pipe OD	L ₁	L ₂	Z ₁	Z ₂	Pack	qty
T-Stück mit gleichgängigem Abgang	Artikel	DN	RohrauBendurchmesse r d	L ₁	L ₂	Z ₁	Z ₂	Stück pro Verpackung	
	DT-P15	12	15	32	39	12	19	20	
	DT-P18	15	18	34	42	14	22	20	
	DT-P22	20	22	37	45	16	24	20	
	DT-P28	25	28	42	52	19	29	10	
	DT-P35	32	35	50	58	24	32	10	
	DT-P42	40	42	57	63	27	33	4	
	DT-P54	50	54	69	78	34	43	2	

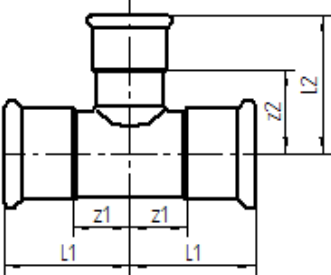
Reducing tee	Article	Nom dia	Outside diameter of pipe OD	L ₁	L ₂	Z ₁	Z ₂	Pack	qty
T-Stück mit reduziertem Abgang	Artikel	DN	RohrauBendurchmesse r d	L ₁	L ₂	Z ₁	Z ₂	Stück pro Verpackung	
	DRT-P1815	15/12	18-15-18	34	41	14	21	20/120	
	DRT-P2215	20/12	22-15-22	37	43	16	23	20/80	
	DRT-P2218	20/15	22-18-22	37	55	16	35	20/80	
	DRT-P2815	25/12	28-15-28	42	45	19	25	10/50	
	DRT-P2818	25/15	28-18-28	42	45	19	25	10/50	
	DRT-P2822	25/20	28-22-28	42	47	19	26	10/50	
	DRT-P3515	32/12	35-15-35	50	49	24	29	10	
	DRT-P3518	32/15	35-18-35	50	50	24	30	10	
	DRT-P3522	32/20	35-22-35	50	51	24	30	10	
	DRT-P3528	32/25	35-28-35	50	52	24	29	10	
	DRT-P4222	40/20	42-22-42	57	53	27	32	4	
	DRT-P4228	40/25	42-28-42	57	56	27	33	4	
	DRT-P4235	40/32	42-35-42	57	61	27	35	4	
	DRT-P5422	50/20	54-22-54	69	59	34	38	2	
	DRT-P5428	50/25	54-28-54	69	64	34	41	2	
	DRT-P5435	50/32	54-35-54	69	67	34	41	2	
	DRT-P5442	50/40	54-42-54	69	70	34	40	2	

TRU-FLOW INDUSTRIAL CO., LTD.



Pressfittings für Trinkwasser-Installation; Systemprüfzeichen DVGW: DW-8511BN0661

Pressfittings installation in portable water supply systems; Bearing DVGW: DW-8511BN0661

Material : Stainless steel Cr-Ni-Mo-steel, material NO.1.4401(316)

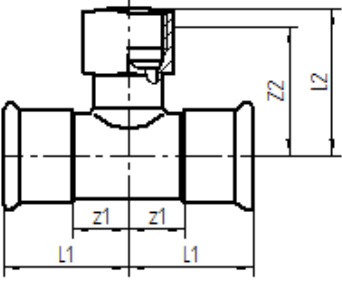
Branch tee BSP female outlet	Article	Nom dia	Outside diameter of pipe female thread	L ₁	L ₂	Z ₁	Z ₂	Pack	qty
T-Stück mit Abgang Innengewinde	Artikel	DN	Rohr- Bendurchmesse r d	L ₁	L ₂	Z ₁	Z ₂	Stück pro Verpackung	
	DTI-P1504	12/15	15-Rp 1/2 -15	32	36	12	21	20	
	DTI-P1804	15	18-Rp 1/2 -18	34	41	14	26	20	
	DTI-P1806	15/20	18-Rp 3/4 -18	34	44	14	28	20	
	DTI-P2204	20/15	22-Rp 1/2 -22	37	40	16	25	20	
	DTI-P2206	20	22-Rp 3/4 -22	37	46	16	30	20	
	DTI-P2804	25/15	28-Rp 1/2 -28	42	42	19	27	10	
	DTI-P2806	25/20	28-Rp 3/4 -28	42	50	19	34	10	
	DTI-P3504	32/15	35-Rp 1/2 -35	50	48	24	33	10	
	DTI-P3506	32/20	35-Rp 3/4 -35	50	54	24	38	10	
	DTI-P4204	40/15	42-Rp 1/2 -42	57	52	27	37	4	
	DTI-P4206	40/20	42-Rp 3/4 -42	57	57	27	41	4	
	DTI-P5404	50/15	54-Rp 1/2 -54	69	57	34	42	2	
	DTI-P5406	50/20	54-Rp 3/4 -54	69	64	34	48	2	
	DTI-P5420	50	54-Rp 2 -54	69	80	34	54	2	

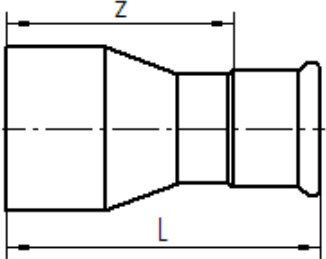
Reducer	Article	Nom dia	Outside diameter of pipe OD	L	Z	Pack	qty
Redu-Stück	Artikel	DN	Rohr- Bendurchmesse r d	L	Z	Stück pro Verpackung	
	DCRS-P1815	15-12	18-15	55	35	20	
	DCRS-P2215	20-12	22-15	59	39	20	
	DCRS-P2218	20-15	22-18	57	37	20	
	DCRS-P2815	25-12	28-15	66	46	20	
	DCRS-P2818	25-15	28-18	64	44	20	
	DCRS-P2822	25-20	28-22	59	38	20	
	DCRS-P3515	32-12	35-15	73	53	10	
	DCRS-P3518	32-15	35-18	71	51	10	
	DCRS-P3522	32-20	35-22	71	50	10	
	DCRS-P3528	32-25	35-28	68	45	10	
	DCRS-P4215	40-12	42-15	81	61	4	
	DCRS-P4218	40-15	42-18	80	60	4	
	DCRS-P4222	40-20	42-22	79	58	4	
	DCRS-P4228	40-25	42-28	79	56	4	
	DCRS-P4235	40-32	42-35	72	46	4	
	DCRS-P5415	50-12	54-15	97	77	4	
	DCRS-P5418	50-15	54-18	96	76	4	
	DCRS-P5422	50-20	54-22	95	74	4	
	DCRS-P5428	50-25	54-28	95	72	4	
	DCRS-P5435	50-32	54-35	95	69	4	
	DCRS-P5442	50-40	54-42	89	59	4	

TRU-FLOW INDUSTRIAL CO., LTD.



Pressfittings für Trinkwasser-Installation; Systemprüfzeichen DVGW: DW-8511BN0661

Pressfittings installation in portable water supply systems; Bearing DVGW: DW-8511BN0661

Material : Stainless steel Cr-Ni-Mo-steel, material NO.1.4401(316)

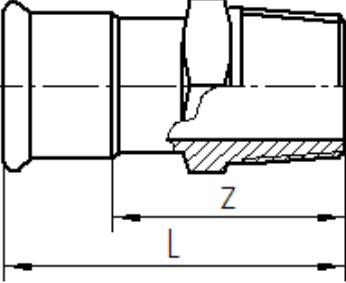
Male adaptor pressfitting / BSP	Article	Nom dia	Outside diameter of pipe male thread	L	Z	Pack qty
Übergangsstück mit Außengewinde	Artikel	DN	Rohr außen Durchmesser Außengewinde	L	Z	Stück pro Verpackung
	DAO-P1504	12-15	15-R 1/2	53	33	20/220
	DAO-P1506	12-20	15-R 3/4	57	37	20
	DAO-P1804	15	18-R 1/2	53	33	20/200
	DAO-P1806	15-20	18-R 3/4	57	37	20/160
	DAO-P2204	20-15	22-R 1/2	54	33	20
	DAO-P2206	20	22-R 3/4	58	37	20/140
	DAO-P2210	20-25	22-R 1	61	40	20
	DAO-P2806	25-20	28-R 3/4	61	38	20
	DAO-P2810	25	28-R 1	64	41	20/80
	DAO-P2812	25-32	28-R 1 1/4	68	45	10
	DAO-P3510	32-25	35-R 1	68	42	10
	DAO-P3512	32	35-R 1 1/4	72	46	10
	DAO-P3514	32-40	35-R 1 1/2	73	47	10
	DAO-P4214	40	42-R 1 1/2	77	47	4
	DAO-P4212	40-32	42-R 1 1/4	78	48	4
	DAO-P5420	50	54-R 2	83	48	4
	DAO-P5414	50-40	54-R 1 1/2	89	54	4

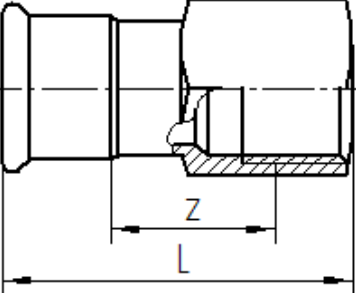
Female adaptor pressfitting / BSP	Article	Nom dia	Outside diameter of pipe female thread	L	Z	Pack qty
Übergangsmuffe mit Innengewinde	Artikel	DN	Rohr innen Durchmesser Innengewinde	L	Z	Stück pro Verpackung
	DAI-P1504	12-15	15-Rp 1/2	59	26	20/240
	DAI-P1506	12-20	15-Rp 3/4	62	28	20
	DAI-P1804	15	18-Rp 1/2	59	26	20
	DAI-P1806	15-20	18-Rp 3/4	62	28	20
	DAI-P2204	20-15	22-Rp 1/2	60	26	20
	DAI-P2206	20	22-Rp 3/4	63	28	20
	DAI-P2210	20-25	22-Rp 1	66	28	20
	DAI-P2806	25-20	28-Rp 3/4	63	26	20
	DAI-P2810	25	28-Rp 1	69	29	20
	DAI-P2812	25-32	28-Rp 1 1/4	71	29	20
	DAI-P3510	32-25	35-Rp 1	67	24	10
	DAI-P3512	32	35-Rp 1 1/4	75	30	10
	DAI-P3514	32-40	35-Rp 1 1/2	75	30	10
	DAI-P4212	40-32	42-Rp 1 1/4	71	22	4
	DAI-P4214	40	42-Rp 1 1/2	79	30	4
	DAI-P5414	50-40	54-Rp 1 1/2	77	23	4
	DAI-P5420	50	54-Rp 2	97	39	4

TRU-FLOW INDUSTRIAL CO., LTD.



Pressfittings für Trinkwasser-Installation; Systemprüfzeichen DVGW: DW-8511BN0661

Pressfittings installation in portable water supply systems; Bearing DVGW: DW-8511BN0661

Material : Stainless steel Cr-Ni-Mo-steel, material NO.1.4401(316)

90° male angle adapter pressfitting / BSP	Article	Nom dia	Outside diameter of pipe male thread	L	h	Z	Pack	qty
Übergangswinkel 90° mit Außengewinde	Artikel	DN	Rohr- Außen- Durchmesser	L	h	Z	Stück pro Verpackung	
	DA90-P1504	12/15	15-R 1/2	57	37	37	20/120	
	DA90-P1804	15	18-R 1/2	57	39	37	20	
	DA90-P2206	20	22-R 3/4	60	46	39	10	
	DA90-P2810	25	28-R 1	67	54	44	10	
	DA90-P3512	32	35-R 1 1/4	75	63	49	10	
	DA90-P4214	40	42-R 1 1/2	84	67	54	2	
	DA90-P5420	50	54-R 2	95	78	60	2	

90° female angle adapter pressfitting / BSP	Article	Nom dia	Outside diameter of pipe female thread	L ₁	L ₂	Z ₁	Z ₂	Pack	qty
Übergangswinkel 90° mit Innengewinde	Artikel	DN	Rohr- Innen- Durchmesser	L ₁	L ₂	Z ₁	Z ₂	Stück pro Verpackung	
	DA9I-P1504	12/15	15-Rp 1/2	57	37	37	24	20/120	
	DA9I-P1804	15	18-Rp 1/2	57	39	37	26	20	
	DA9I-P2206	20	22-Rp 3/4	60	46	39	31	10	
	DA9I-P2810	25	28-Rp 1	67	54	44	37	10	
	DA9I-P3512	32	35-Rp 1 1/4	75	63	49	44	10	

90° female extension elbow plain end/BSP	Article	Nom dia	Outside diameter of pipe female thread	L	h	z	Pack	qty
Ansatzwinkel 90° mit Innengewinde und einseitigem Einschleibende	Artikel	DN	Rohr- Innen- Durchmesser	L	h	z	Stück pro Verpackung	
	DA9IS-P1504	12/15	15-Rp 1/2	36	53	23	20	

TRU-FLOW INDUSTRIAL CO., LTD.



Pressfittings für Trinkwasser-Installation; Systemprüfzeichen DVGW: DW-8511BN0661

Pressfittings installation in portable water supply systems; Bearing DVGW: DW-8511BN0661

Material : Stainless steel Cr-Ni-Mo-steel, material NO.1.4401(316)

90° female angle adapter pressfitting / BSP	Article	Nom dia	Outside diameter of pipe female thread	L ₁	L ₂	A	B	Z ₁	Z ₂	D	X	Pack qty
Deckenwinkel 90° mit Innengewinde	Artikel	DN	Rohr-Äußendurchmesser Innengewinde	L ₁	L ₂	A	B	Z ₁	Z ₂	D	X	Stück pro Verpackung
	DA9-P1504	12	15-Rp 1/2	50	30	43	13	28	17	5	34	20/120
	DA9-P1804	15	18-Rp 1/2	50	30	43	13	30	17	5	34	20
	DA9-P2206	20	22-Rp 3/4	54	34	51	17	33	20	6	40	20

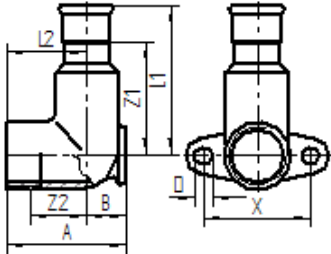

90° female elbow with wall plate / WCI BSP / pressfitting	Article	Nom dia	Outside diameter of pipe female thread	L ₁	L ₂	A	B	Z ₁	Z ₂	D	X	Pack qty
Deckenwinkel 90° / WA mit Innengewinde	Artikel	DN	Rohr-Äußendurchmesser Innengewinde	L ₁	L ₂	A	B	Z ₁	Z ₂	D	X	Stück pro Verpackung
	DA9L-P1504	12	15-Rp 1/2	50	30	65	35	30	17	17	34	20
	DA9L-P1804	15	18-Rp 1/2	50	30	65	35	30	17	17	34	20
	DA9L-P2206	20	22-Rp 3/4	54	34	65	31	34	20	18	40	20

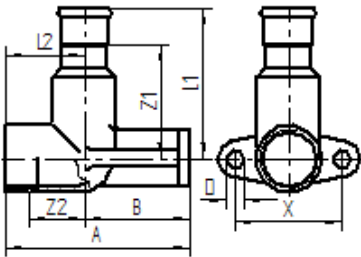

90°/2 female elbow with wall plate BSP / 2 pressfitting outlets	Article	Nom dia	Outside diameter of pipe female thread	L ₁	L ₂	A	B	Z ₁	Z ₂	D	X	Pack qty
Deckenwinkel 90° / 2 mit Innengewinde	Artikel	DN	Rohr-Äußendurchmesser Innengewinde	L ₁	L ₂	A <td>B <td>Z₁</td> <td>Z₂</td> <td>D <td>X</td> <td>Stück pro Verpackung</td> </td></td>	B <td>Z₁</td> <td>Z₂</td> <td>D <td>X</td> <td>Stück pro Verpackung</td> </td>	Z ₁	Z ₂	D <td>X</td> <td>Stück pro Verpackung</td>	X	Stück pro Verpackung
	DA9T-P1504	12	15-Rp 1/2-15	60	30	45	13	40	17	5	39	20

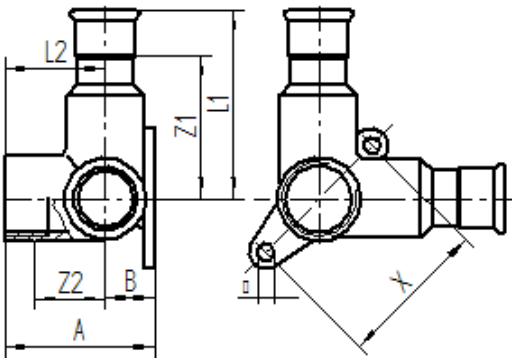

TRU-FLOW INDUSTRIAL CO., LTD.



Pressfittings für Trinkwasser-Installation; Systemprüfzeichen DVGW: DW-8511BN0661

Pressfittings installation in portable water supply systems; Bearing DVGW: DW-8511BN0661

Material : Stainless steel Cr-Ni-Mo-steel, material NO.1.4401(316)

Plug	Article	Nom dia	Outside diameter of pipe OD	L	e	Pack	qty
Verschlussstopfen	Artikel	DN	Rohr Außendurchmesser r d	L	e	Stück pro Verpackung	
	DC-P15	12	15	33	20	20	
	DC-P18	15	18	33	20	10	
	DC-P22	20	22	34	21	10	
	DC-P28	25	28	36	23	10	
	DC-P35	32	35	40	26	10	
	DC-P42	40	42	44	30	4	
	DC-P54	50	54	49	35	4	

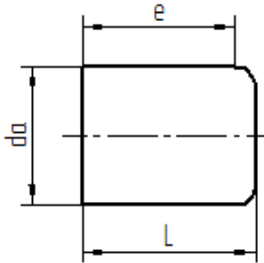

Adaptor flange

Übergangsfansch

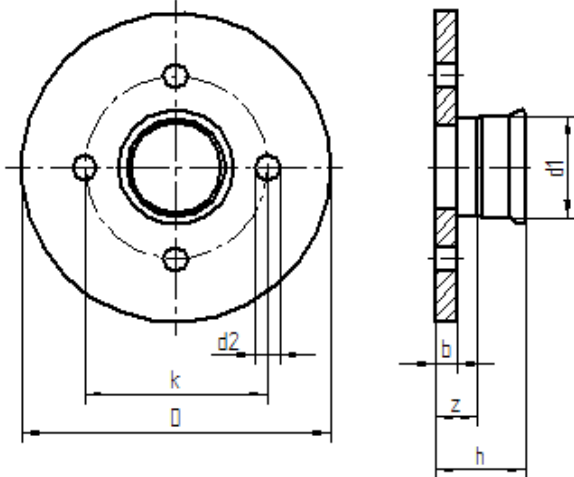

Nominal Size			Article	D	k	b	h	z	d2	n	Pack	qty
DN	x	d										
12	x	15	DF-P15	95	65	11	56	36	14	4	1	
15	x	18	DF-P18	95	65	11	57	37	14	4	1	
20	x	22	DF-P22	105	75	12	59	38	14	4	1	
25	x	28	DF-P28	115	85	14	65	42	14	4	1	
32	x	35	DF-P35	140	100	15	69	43	18	4	1	
40	x	42	DF-P42	150	110	16	77	47	18	4	1	
50	x	54	DF-P54	165	125	18	87	52	18	4	1	